

ELECTRIC FLAT PANEL FIREPLACE HEATER

Model# : ■ VESTA42

■ VESTA50

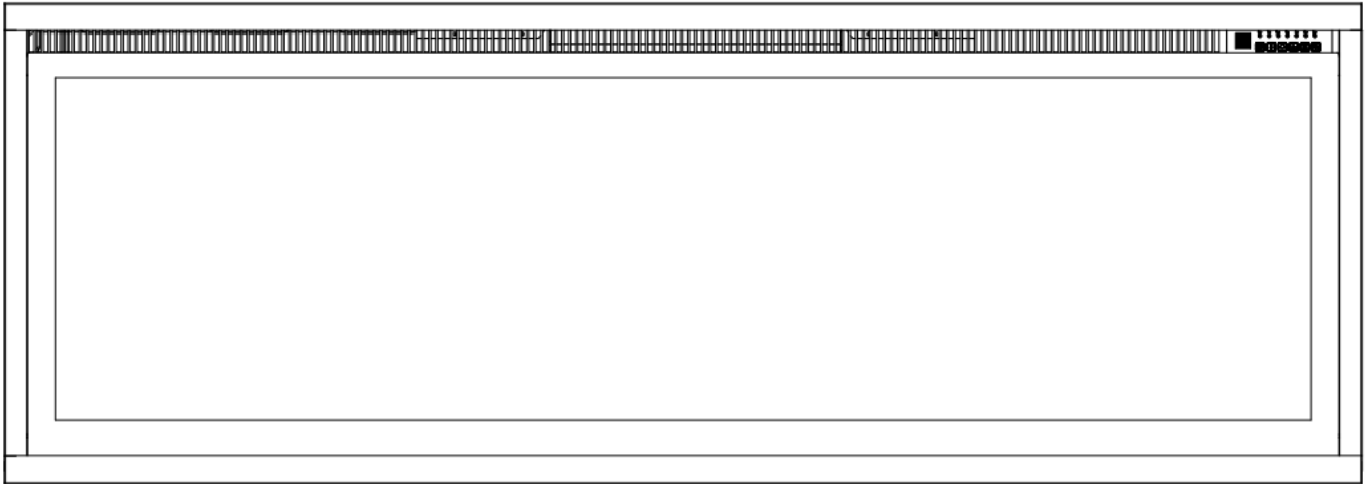
■ VESTA60

■ VESTA72

■ VESTA100

OWNER'S MANUAL

Luminara



42"/50"/60"/72"/100" Wall Mounted / Built-in Electric Fireplace

AC 120V 60Hz 1500W



⚠ WARNING

Read and understand this entire owner's manual, including all safety information, before plugging in or using this product. Failure to do so could result in fire, electric shock, or serious personal injury.

⚠ CAUTION

Keep this owner's manual for future reference. If you sell or give this product away, make sure this manual accompanies this product.

IMPORTANT SAFETY INFORMATION!

WARNING

When using electrical appliances basic precautions should always be followed to reduce the risk of fire, electric shock and injury to persons, including the following:

- Read all instructions before using this heater.
- This heater is hot when in use. To avoid burning, do not touch hot surface. If provided, use handles when moving this heater. Keep combustible materials, such as furniture, pillows, bedding, papers, clothes, and curtains at least 1 m from the front of the heater and keep them away from the sides and rear. In order to avoid overheating, do not cover the heater.
- Extreme caution is necessary when any heater is used near children or the infirm and whenever the heater is left operating and unattended.
- If leaving for an extended period, it is suggested that you turn the power off to the unit.
- Do not operate any heater with a damaged cord or plug or after the heater malfunctions, has been dropped damaged in any manner, return heater to authorized service facility for examination, electrical or mechanical adjustment, or repair.
- Indoor use only, do not use outdoors.
- This heater is not intended for use in bathrooms, laundry areas and similar indoor locations. Never locate heater where it may fall into a bathtub or other water container.
- Do not run cord under carpeting. Do not cover cord with throw rugs, runners, or similar coverings. Arrange cord away from traffic area and where it will not be tipped over.
- To disconnect heater, turn controls to off, then remove plug from outlet.
- Do not inset or allow foreign objects to enter any ventilation or exhaust opening as this may cause an electric shock or fire, or damage the heater.
- To prevent a possible fire, do not block air intakes or exhaust in any manner. Do not use on soft surfaces, like a bed, where openings may become blocked.
- A heater has hot and arcing or sparking parts inside. Do not use it in areas where gasoline, or flammable liquids are used or stored.
- Use this heater only as describes in this manual. Any other use not recommended by the manufacturer may cause fire, electric shock, or injury to persons.
- DANGER-HIGH Temperatures may be generated under certain abnormal conditions. Do not partially or fully cover or obstruct the front of this heater.
- Replacement of the lamps should be done only while the heater is disconnected from the supply circuit.
- This appliance is not intended for use by persons (including children) with reduced physical, sensory or capabilities, or lack of experience and knowledge, unless they have been given supervision or instruction concerning use of the appliance by a person responsible for their safety. Children should be supervised to ensure that they do not play with the appliance.
- CAUTION: In order to avoid a hazard due to inadvertent resetting of the thermal cut-out, this appliance must not be supplied through an external switching device, such as a timer, or connected to a circuit that is regularly switched on and off by the utility.

Preparation



This product includes a **GLASS panel** ! Always use **extreme caution** when handling glass. Failure to do so could result in **personal injury or property damage**.

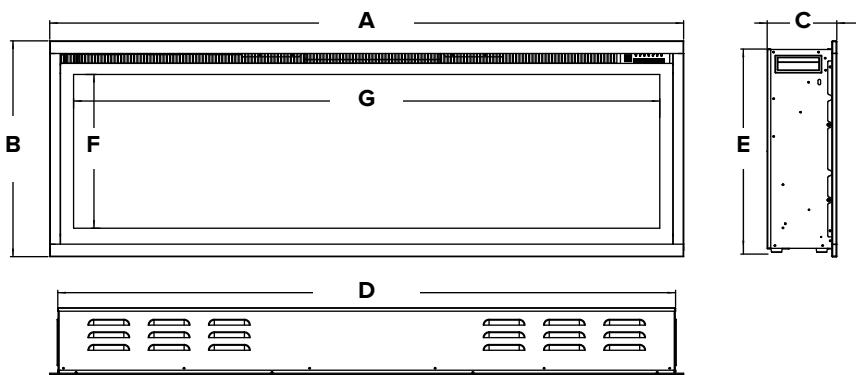
Remove all parts and hardware from the carton and place them on a clean, soft, dry surface. Parts and assembly steps are grouped for wall-hanging or recessing use. Check the parts list to make sure nothing is missing. Dispose of packaging materials properly. Please recycle whenever possible.

You will need the following tools (not included): Phillips screwdriver; stud finder; level; tape measure; electric drill; 1/4" wood drill bit, hammer.

Parts and Hardware

<p>A – Fireplace</p>			
		<p>B – Wood Screws C – Drywall anchors</p>	
		<p>Remote Control</p>	
<p>E – Wall Bracket Fixed on back of firebox</p>	<p>F – Plastic Strip</p>	<p>G – Decorative Crystals (Small & Big)</p>	<p>H – Wood log</p>

Specification and Dimension



Description	Electric Fireplace
Type	3 Way Mounting Unit Wall-Mount, Recess into Wall and Assemble with mantel
Voltage	110-120V AC
Watts	1500W
Amps	10AMP Grounded Circuit

See Next Page for Dimensions

PRODUCT DIMENSIONS

Model Number	A	B	C	D	E	F	G
VESTA42	41-3/4" [1060mm]	17" [430mm]	5- 1/2" [140mm]	40- 7/16" [1027mm]	16" [406mm]	12" [306mm]	38" [965mm]
VESTA50	49-3/4" [1262mm]	17" [430mm]	5- 1/2" [140mm]	48- 7/16" [1230mm]	16" [406mm]	12" [306mm]	46" [1168mm]
VESTA60	59-3/4" [1516mm]	17" [430mm]	5- 1/2" [140mm]	58- 7/16" [1484mm]	16" [406mm]	12" [306mm]	56" [1422mm]
VESTA72	71-3/4" [1821mm]	17" [430mm]	5- 1/2" [140mm]	70- 7/16" [1789mm]	16" [406mm]	12" [306mm]	68" [1727mm]
VESTA100	99-3/4" [2533mm]	17" [430mm]	5- 1/2" [140mm]	98- 7/16" [2500mm]	16" [406mm]	12" [306mm]	96" [2438mm]

Installation and Assembly

Your appliance is a wall-mounted, recessed and/or mantel installed appliance. Select a suitable location that is not susceptible to moisture and is away from drapes, furniture and high traffic areas.

NOTE: Follow all National and local electrical codes.

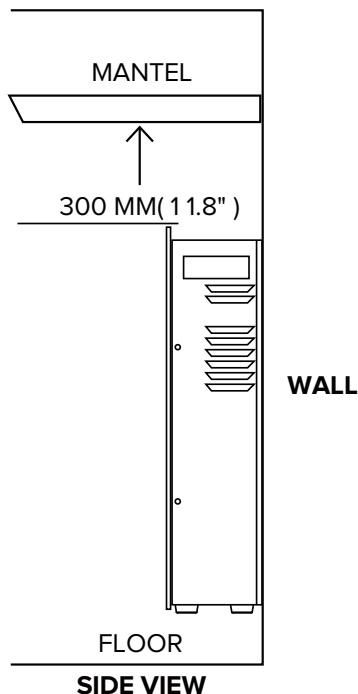
MINIMUM CLEARANCE TO COMBUSTIBLES

Measurements are taken from the glass front.			
Bottom	0"	Top	8" (300mm) to mantel
Sides	0"	Top	8" (300mm) to ceiling
Back	0"		

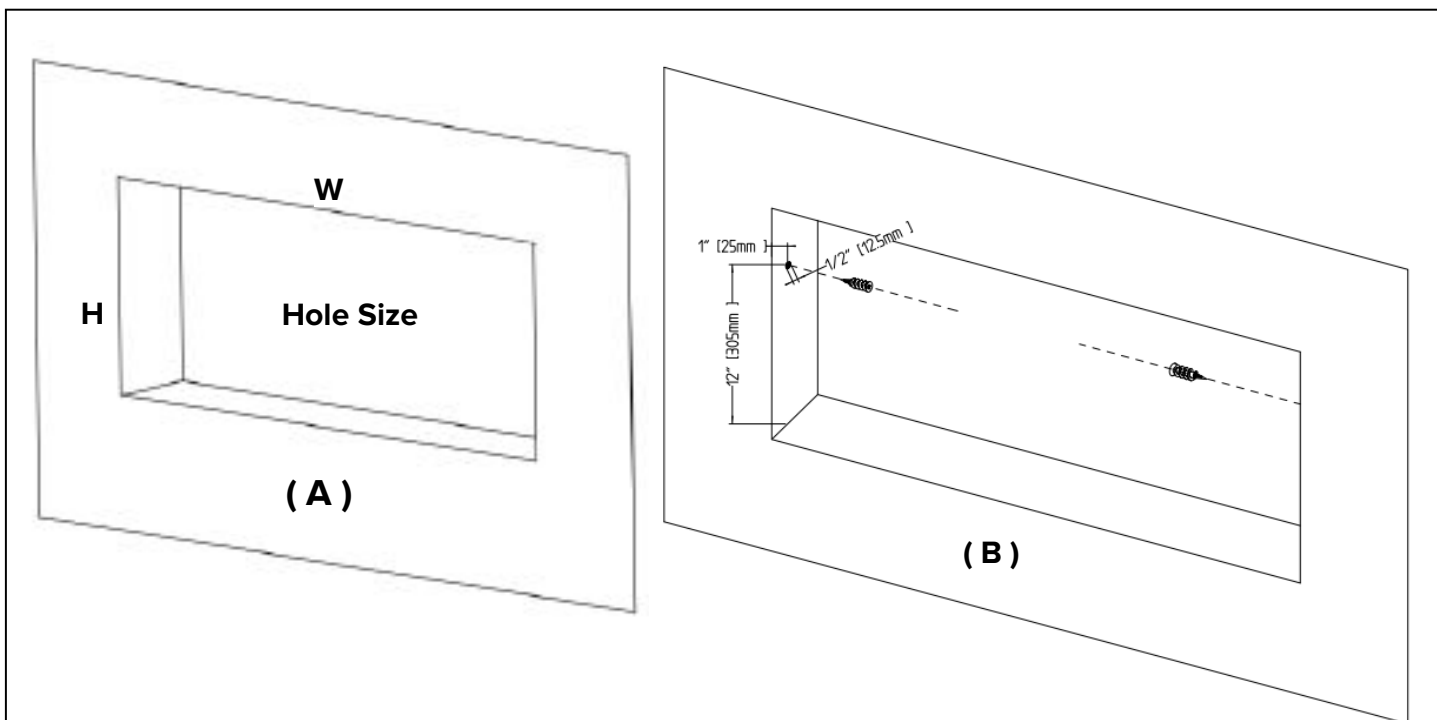
MINIMUM MANTEL CLEARANCES

WARNING

WHEN USING PAINT OR LACQUER TO FINISH THE MANTEL, THE PAINT OR LACQUER MUST BE HEAT RESISTANT TO PREVENT DISCOLOURATION.



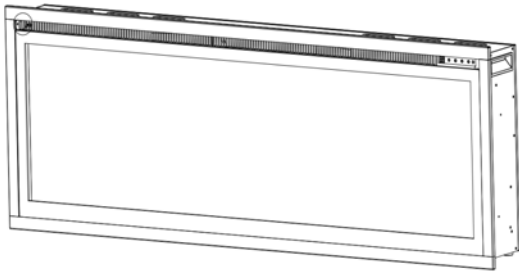
RECESSED TO WALL INSTALLATION



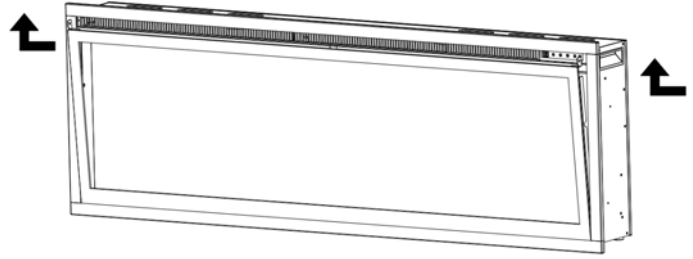
STEP A. Selection a dry wall to open a hole for fireplace box. Size of hole as below chart. **Figure (A)**

Framing Hole Size		
Model Number	W	H
VESTA42	40- 3/4" [1035mm]	16-1/4" [413mm]
VESTA50	48- 3/4" [1238mm]	16-1/4" [413mm]
VESTA60	58- 3/4" [1492mm]	16-1/4" [413mm]
VESTA72	70- 3/4" [1797mm]	16-1/4" [413mm]
VESTA100	98- 3/4" [2508mm]	16-1/4" [413mm]

STEP B. Fix the wall anchors in each side of the fireplace box according to the dimensions showed on the drawing. **Figure (B)**



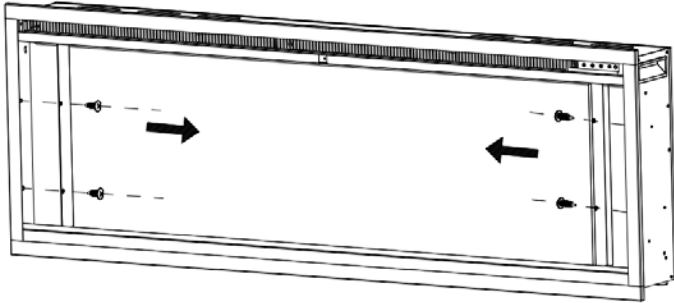
(C)



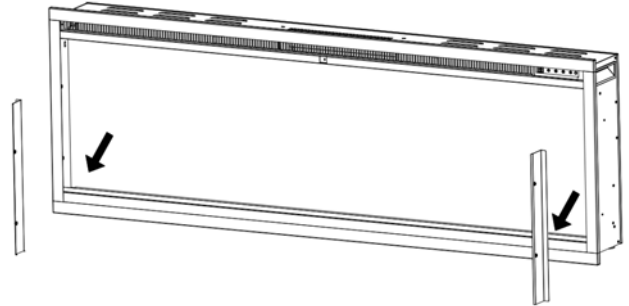
(D)

STEP C. Take off the screw in both sides of the glass panel. **Figure (C)**

STEP D. Have two person to take the glass panel out of the fireplace box. Place it to a soft and clean place. **Figure (D)**

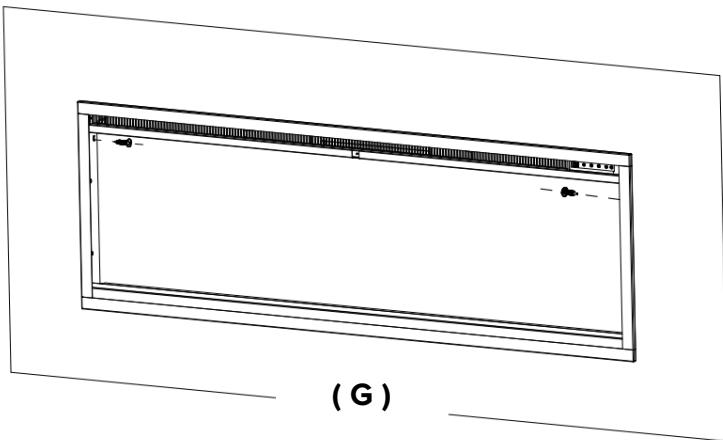


(E)

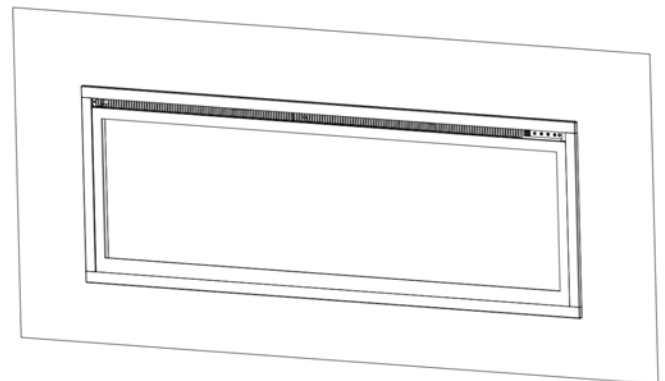


(F)

STEP E. Take off the two screws in both sides, then take off the two metal brackets, keep them well as you will need to screw back . **Figure (E, F)**



(G)



(H)

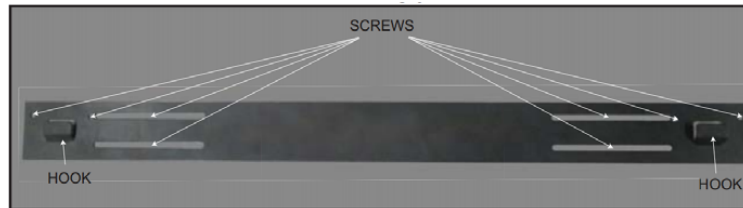
STEP F. Have two person to move the fireplace box to the wall hole. With the appliance is fully recessed into the wall.

- Use the 2 screws (provided) to lock the appliance into the wall with the existing two sides see **Figure (G)**
- Install the media and re-install the glass front. **Figure (H)**

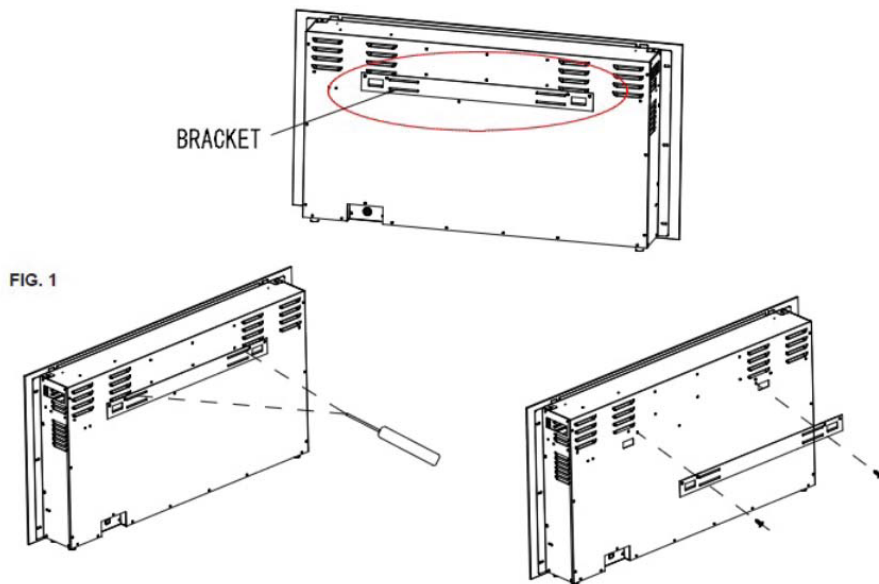
Wall Mounted Installation

Due to the many different materials used on different walls, it is highly recommended that you consult your local builder before you install this appliance on the wall.

- A.** Select a location that is not prone to moisture and is located at least 36" (914mm) away from combustible materials such as curtain drapes, furniture, bedding, paper, etc.
- B.** Have two people hold the appliance against the wall to determine the final location.
- C.** Place unit face down on a soft, non abrasive surface. Remove the bracket from the back of the unit by removing the screws, refer to Figure 1.
- D.** Mark out location, then mount the bracket(s) onto the wall using the supplied screws. This bracket **MUST** have the hooks facing upward and be level. **NOTE: It is strongly recommended that the mounting bracket (E) be Screwed into the wall studs Where possible. If the wall studs cannot be used, ensure that the supplied plastic anchors are used to affix the bracket to the wall and the bracket is adequately secured.**



- E.** With the wall mounting bracket installed have two people lift the appliance up and insert the two hooks on the bracket into the two slots on the back of the appliance.
- F.** Check the appliance for stability ensuring that the bracket will not pull free from the wall.



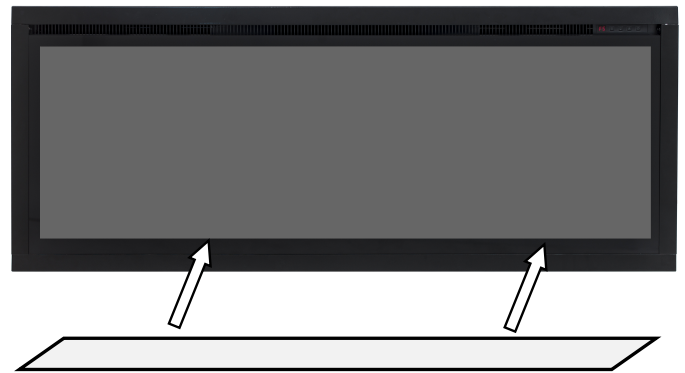
Wall Bracket Illustrated

Crystals and Log-set Installation

- A. Glass front must be removed and the appliance must be mounted in its final location before the crystals and log-set are installed.
- B. Remove the log-set from the package, put it to the ember bed slot. **Fig.1**
- C. To switch to crystals. Place the white plastic strip to the fireplace ember bed. Then carefully place the crystals onto the bottom tray on the front of the appliance as illustrated. Apply an even layer from side to side. **Fig.2, Fig.3**



Log-set (Fig.1)



Plastic Strip (Fig.2)



Crystals (Fig.3)

HARD WIRING INSTALLATION

WARNING

TURN OFF THE APPLIANCE COMPLETELY AND LET COOL BEFORE SERVICING. ONLY A QUALIFIED SERVICE PERSON SHOULD SERVICE AND REPAIR THIS ELECTRIC APPLIANCE.

HARD WIRING CONNECTION

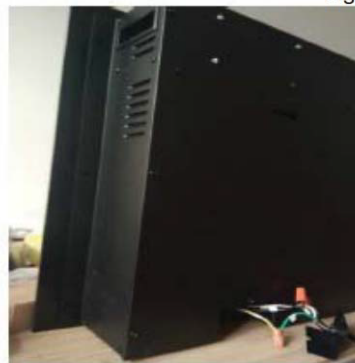
If it is necessary to hard wire this appliance, a qualified electrician must remove the cord connection, and wire the appliance directly to the household wiring.

This appliance must be electrically connected and grounded in accordance with local codes, if hard wired. In the absence of local codes, use the current CSA C22.1 CANADIAN ELECTRICAL CODE in Canada or the current ANSI/NFPA 70 NATIONAL ELECTRICAL CODE in the United States.

Fig. 1

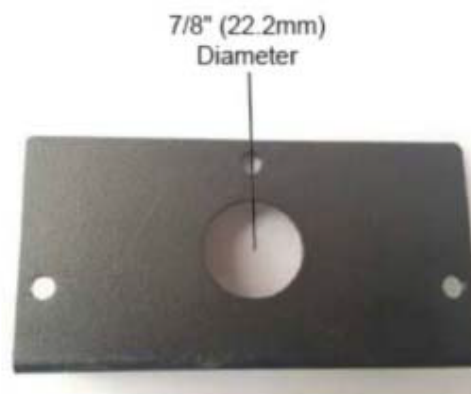
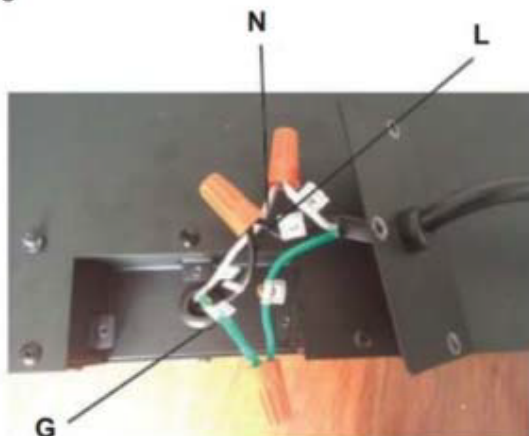


Fig. 2




- A. Remove the cover plate from the right-side bottom of the appliance by removing the three screws, as shown above.
- B. Remove the wire connectors from the power cord. The power cord may be discarded.
- C. Take the new cover plate, supplied in the hardware bag. Punch out the 7/8" (22.2mm) hole and install a box connector through, into the junction box. Snap the box connector clamp onto the supply wires.
- D. Using the wire connectors, connect the ground green wires (G), the common white wires (N) together, then the hot black wires (L) and then the refer to Figure 3.
- E. Re install the cover plate using the three screws, as shown in Figure 1.

Fig. 3



Operation

 **Read and understand** this entire owner’s manual, including **all safety information**, before **plugging in** or **using** this product. Failure to do so could result in **electric shock, fire, serious injury, or death.**

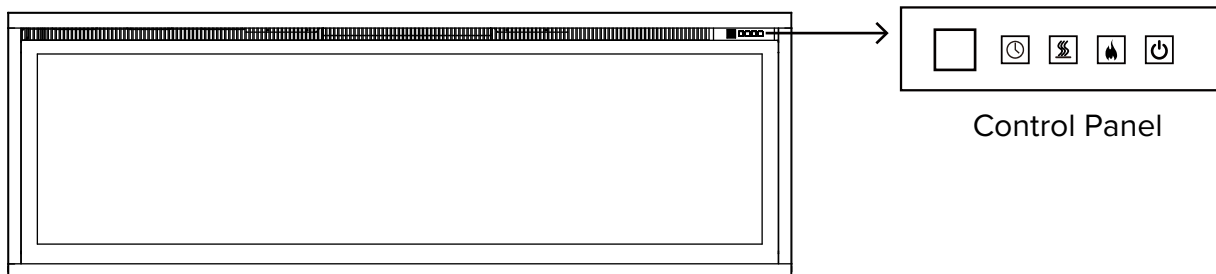
Power

Plug the power cord into a AC 110-120 Volt outlet (see **IMPORTANT SAFETY INFORMATION on Page 2**). Make sure the outlet is in good condition and that the plug is not loose. **NEVER** exceed the maximum amperage for the circuit. **DO NOT** plug other appliances into the same circuit.

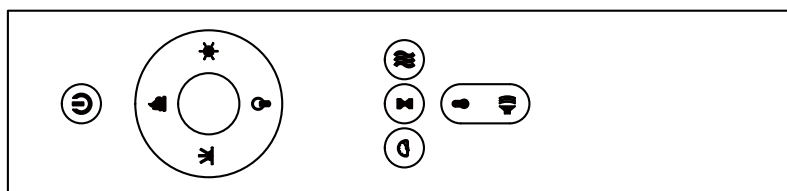
Methods of Operation

This electric fireplace can be operated by the CONTROL PANEL, through the Wifi App or by the battery-powered REMOTE CONTROL.

Before operating, please review the **IMPORTANT SAFETY INFORMATION on Page 2**, and heed all warnings.







Control Panel







Remote Control







Control Panel Operation

BUTTON	FUNCTION	ACTION & INDICATION
 POWER	ON: Enables control panel functions and remote control. Turns on flame effect. OFF: Disables control panel functions and remote control. Turns off flame effect.	1. Press once. Indicator light turns on. Power turns on. All functions enabled. 2. Press again. Flame effect turns off. Unit goes to standby. All functions turn off.

BUTTON	FUNCTION	ACTION & INDICATION
 COLOR	COLOR button: Makes the color flame effect changing. NOTE: color effect stays on until power button is turned off. Color flame effect must be on for heater to turn on.	<ol style="list-style-type: none"> Press once. Flame color effect gets changing. Press again. until desired setting is reached. In total with 6 color flames.
 HEATER	HEATER button: Turns heater on and off. NOTE: The heater only works when the flame effect is on. If the flame effect is off, the heater will not turn on. NOTE: Heater button can be locked or unlocked by holding the Heater button for 5 seconds.	<ol style="list-style-type: none"> Press once. Indicator lights up. Fan blows cool air for 20 seconds. 750W heater turns on and blows warm air. Press again. Indicator lights up. 1500W heater turns on and blows hot air. Press again. Heaters turn off. The fan blows cool air for 30 seconds to allow heater to cool down, then turns off.
 TIMER	TIMER button: Controls timer settings to turn off fireplace at selected time. Settings range from 0.5 hour to 8 hours.	<ol style="list-style-type: none"> Press once. Indicator light turns on. Timer defaults to 0.5 hour. Press again. until desired setting is reached. Indicator lights show setting.

Remote Control Operation

BUTTON	FUNCTION	ACTION & INDICATION
 POWER	ON: Enables control panel functions and remote control. Turns on flame effect. OFF: Disables control panel functions and remote control. Turns off flame effect.	<ol style="list-style-type: none"> Press once. Indicator light turns on. Power turns on. All functions enabled. Press again. Flame effect turns off. Unit goes to standby. All functions turn off.
 COLOR	COLOR button: Makes the color flame effect changing. NOTE: color effect stays on until power button is turned off. Color flame effect must be on for heater to turn on.	<ol style="list-style-type: none"> Press once. Flame color effect gets changing. Press again. until desired setting is reached. In total with 6 color flames.
 HEATER	HEATER button: Turns heater on and off. NOTE: The heater only works when the flame effect is on. If the flame effect is off, the heater will not turn on. NOTE: Heater button can be locked or unlocked by holding the Heater button for 5 seconds.	<ol style="list-style-type: none"> Press once. Indicator lights up. Fan blows cool air for 20 seconds. 750W heater turns on and blows warm air. Press again. Indicator lights up. 1500W heater turns on and blows hot air. Press again. Heaters turn off. The fan blows cool air for 30 seconds to allow heater to cool down, then turns off.
 TIMER	TIMER button: Controls timer settings to turn off fireplace at selected time. Settings range from 0.5 hour to 8 hours.	<ol style="list-style-type: none"> Press once. Indicator light turns on. Timer defaults to 0.5 hour. Press again. until desired setting is reached. Indicator lights show setting.

BUTTON	FUNCTION	ACTION & INDICATION																																						
 FLAME BRIGHTNESS	FLAME BRIGHTNESS button: Makes flame dimmer and brighter. NOTE: Flame effect stays on until power button is turned off. Flame effect must be on for heater to turn on.	<ol style="list-style-type: none"> Press once. Flame brightness is enabled. Press again. until desired setting is reached. There is a total of 5 brightness levels. 																																						
 SPEED	FLAME SPEED button: Controls the speed of the flame. There are 3 flame speed settings: 01 (slow), 02 (medium), 03 (fast).	<ol style="list-style-type: none"> Press once. Flame speed gets changing. Press again. until desired setting is reached. Display shows the setting. The Default setting is 02 (medium speed). 																																						
 TEMP	TEMPERATURE button: Changes the temperature settings. <ol style="list-style-type: none"> Press once. Control panel indicator becomes active. Press again. until desired setting is reached. The display shows below settings: <table border="1" data-bbox="282 682 1414 814"> <thead> <tr> <th>Display Value</th> <th>NO</th> <th>1</th> <th>2</th> <th>3</th> <th>4</th> <th>5</th> <th>6</th> <th>7</th> <th>8</th> <th>9</th> <th>10</th> <th>11</th> </tr> </thead> <tbody> <tr> <td>Temperature</td> <td>°C</td> <td>20</td> <td>21</td> <td>22</td> <td>23</td> <td>24</td> <td>25</td> <td>26</td> <td>27</td> <td>28</td> <td>29</td> <td>30</td> </tr> <tr> <td></td> <td>°F</td> <td>68</td> <td>70</td> <td>72</td> <td>74</td> <td>76</td> <td>78</td> <td>80</td> <td>82</td> <td>84</td> <td>86</td> <td>88</td> </tr> </tbody> </table> NOTE: Press the button for 5 seconds to switch between °C and °F.	Display Value	NO	1	2	3	4	5	6	7	8	9	10	11	Temperature	°C	20	21	22	23	24	25	26	27	28	29	30		°F	68	70	72	74	76	78	80	82	84	86	88
Display Value	NO	1	2	3	4	5	6	7	8	9	10	11																												
Temperature	°C	20	21	22	23	24	25	26	27	28	29	30																												
	°F	68	70	72	74	76	78	80	82	84	86	88																												
 CRACKING SOUND	CRACKING SOUND button: Makes cracking sound low or high. S3 (high), S2 (medium), S1 (low), S0 (off).	<ol style="list-style-type: none"> Press once. Cracking sound is enabled. Press again. until desired setting is reached. The Default setting is S2 (medium). 																																						
 EMBER BED LIGHTS	EMBER BED LIGHTS button: Turns on media bed and changes color. NOTE: This fireplace has memory function for ember bed lighting.	<ol style="list-style-type: none"> Press once. Ember bed turns on. Press again. until desired setting is reached. There is a total of 10 ember bed colors. 																																						
 EMBER BED BRIGHTNESS	EMBER BED BRIGHTNESS button: Makes media bed dimmer and brighter.	<ol style="list-style-type: none"> Press once. Brightness becomes active. Press again. until desired setting is reached. There is a total of 4 brightness levels and 1 pulsating level. 																																						

NOTICE

When the heater is first turned on, a slight odor may be present. This is normal and should not occur again unless the heater is not used for a long period of time.

NOTICE

To improve operation, aim the remote control at the front of the fireplace. **DO NOT press the buttons too quickly.** Give the unit time to respond to each command.

Temperature Limiting Control

This heater is equipped with a Temperature Limiting Control. Should the heater reach an unsafe temperature, the heater will automatically turn OFF. To reset:

1. Unplug the power cord from the outlet.
2. Turn the ON/OFF switch on the CONTROL PANEL to OFF. Wait 5 minutes.
3. Inspect the fireplace to make sure no vents are blocked, or clogged with dust or lint. If they are, use a vacuum to clean the vent areas.
4. With the POWER switch in the OFF position, plug the power cord back into the outlet.
5. If the problem continues, have your outlet and wiring inspected by a professional.

Remote Control Battery Information

Remote control uses two **AAA** batteries. **(Not Included)**



NEVER dispose of batteries in fire. Failure to observe this precaution **may result in an explosion.** Dispose of batteries at your local hazardous material processing center.

Care and Maintenance

Cleaning



ALWAYS turn the heater **OFF and unplug the power cord from the outlet** before cleaning, performing maintenance, or moving this fireplace. Failure to do so could result in **electric shock, fire, or personal injury.**



NEVER immerse in water or spray with water. Doing so could result in **electric shock, fire, or personal injury.**

Metal:

- Buff using a soft cloth, slightly dampened with a citrus oil-based product.
- **DO NOT** use brass polish or household cleaners as these products will damage the metal trim.

Glass:

- Use a good quality glass cleaner sprayed onto the cloth or towel. Dry thoroughly with a paper towel or lint-free cloth.
- **NEVER** use abrasive cleansers, liquid sprays, or any cleaner that could scratch the surface.

Vents:

- Use a vacuum or duster to remove dust and dirt from the heater and vent areas.

Plastic:

- Wipe gently with a slightly damp cloth and a mild solution of dish soap and warm water.
- **NEVER** use abrasive cleansers, liquid sprays, or any cleaner that could scratch the surface.

Maintenance



Risk of electric shock! DO NOT OPEN any panels ! No user-serviceable parts inside!



ALWAYS turn the heater **OFF** and **unplug the power cord from the outlet** before cleaning, performing maintenance, or moving this fireplace. Failure to do so could result in **electric shock, fire, or personal injury**.

Electrical and Moving Parts:

- The fan motors are lubricated at the factory and will not require lubrication.
- Electrical components are integrated in the fireplace and are not serviceable by the consumer.

Storage:

- Store heater in a clean dry place when not in use.



WARNING! NO SERVICING of the internal or electrical parts should be performed by the consumer. Do not service the unit yourself.

APP CONNECTION INSTRUCTIONS

1. App download

- Download "Tuya Smart" from the app store.
- Scan the QR code.
- Turn on the "GPS" from your mobile device.

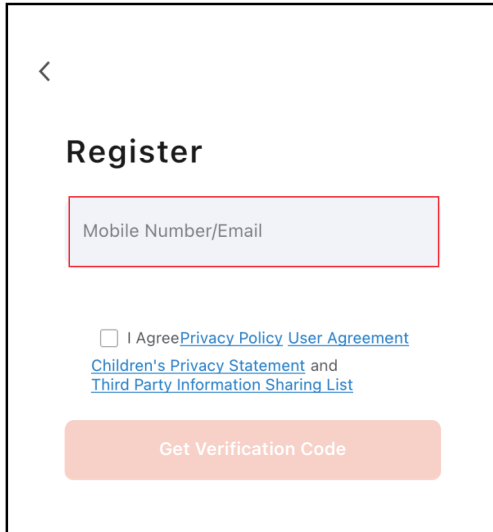


NOTICE

make sure your mobile phone is well connected to the nearest WIFI signal.

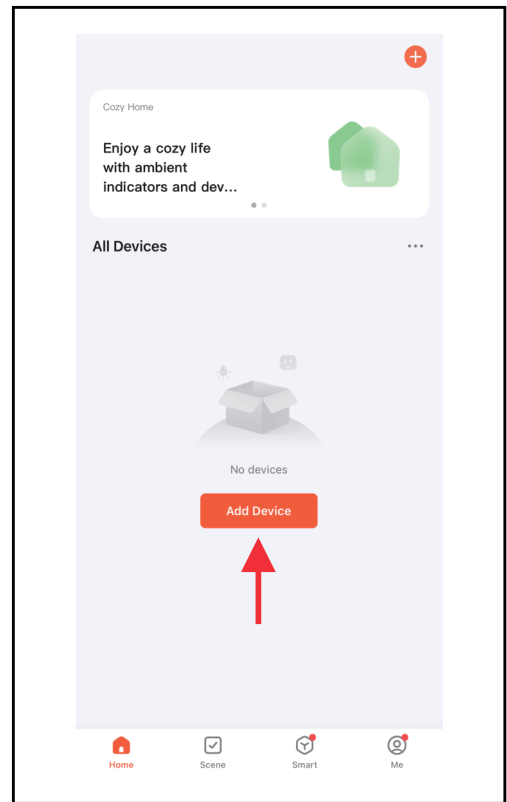
2. Login

- Register with your email ID or Mobile phone number as the user name.
- Setup your account password.



3. Add device

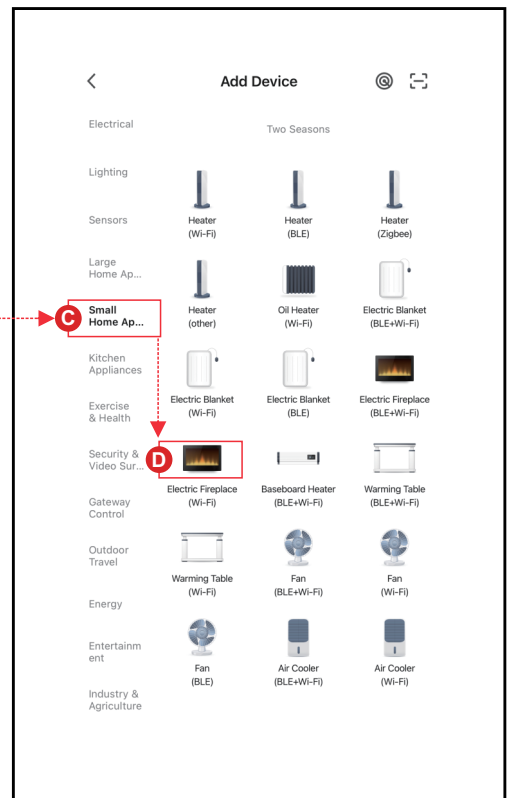
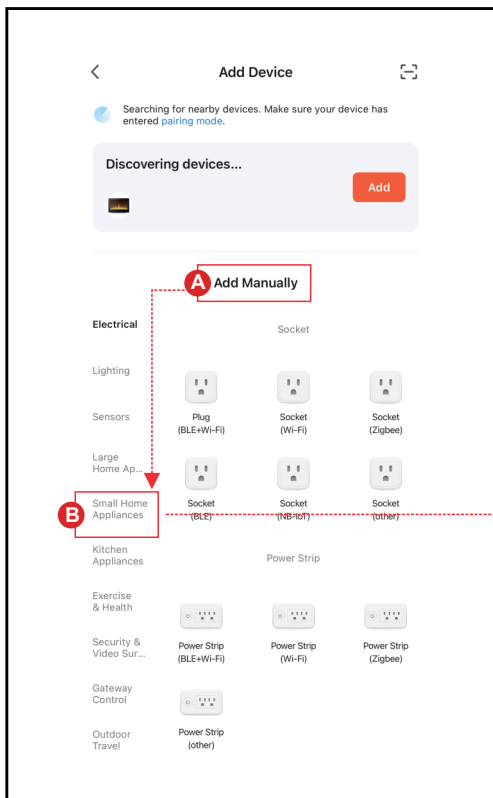
After account is created, log into account and select the "Add Device" button.



3. Add device - Continued


There are three methods to add your Electric Fireplace.

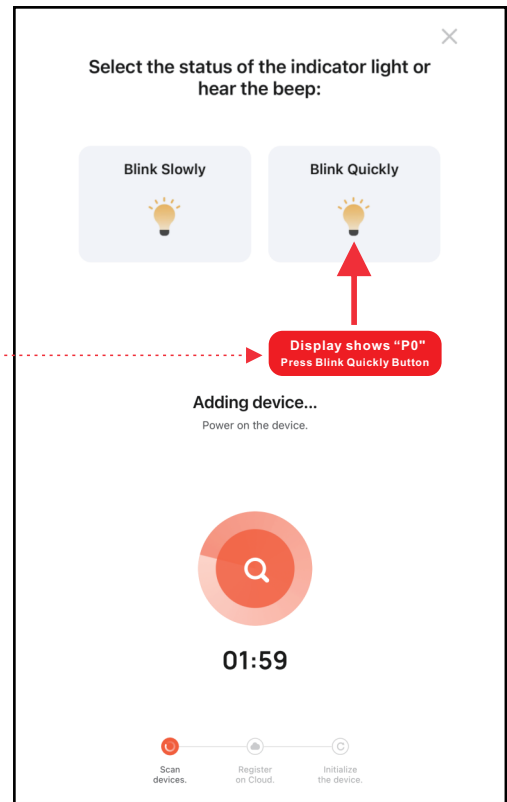
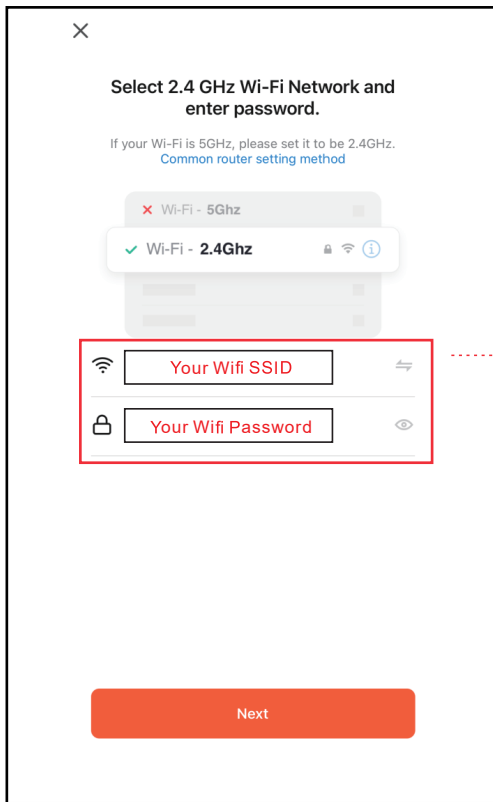
- Method 1: Add Manually on "P0" mode. Please follow below steps A,B,C,D.
- Method 2: Add Manually on "P1" mode. Please follow below steps A,B,C,D.
- Method 3: Add by Bluetooth. Open Bluetooth on your mobile phone before adding.




APP CONNECTION INSTRUCTIONS

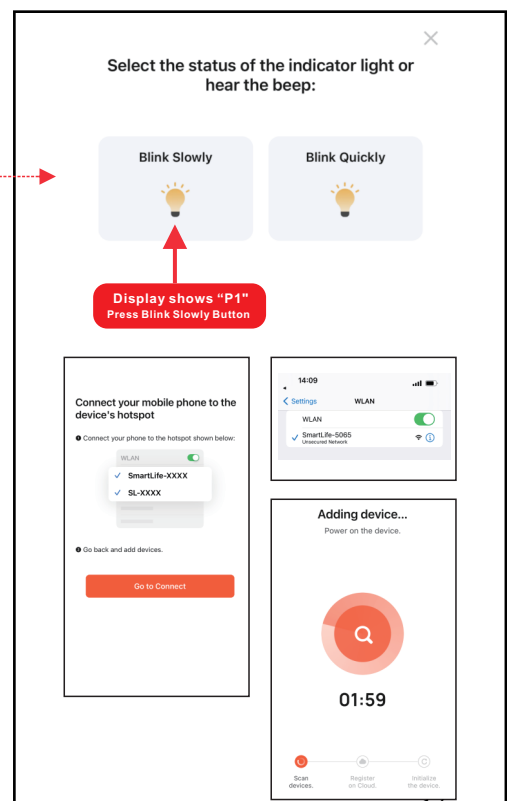
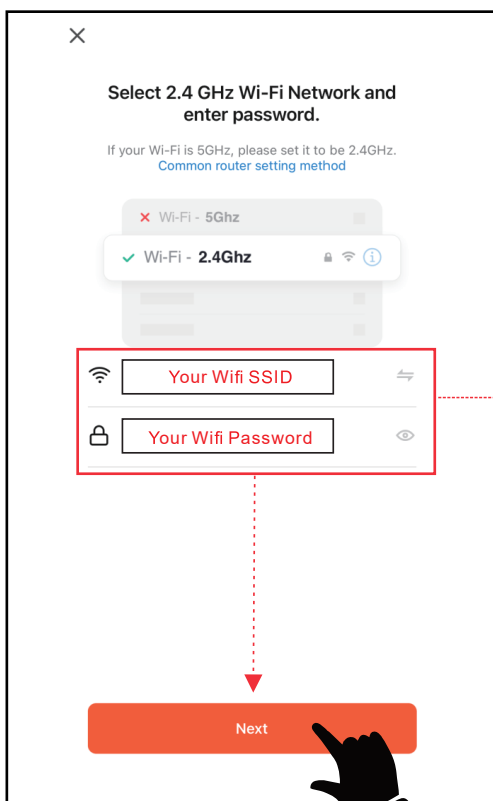
4. Connecting method 1 - (P0)

- Press & hold  from remote control or control panel until display on control panel shows “P0”.
- Enter the WIFI name and password, then press “Next” button for pairing.
- Press the **Blink Quickly** button for “P0”, device being added.
- When complete, display on control panel shows “P4”, LED Ember-light shows **GREEN** color and flashes 6 times.




4. Connecting method 2 - (P1)

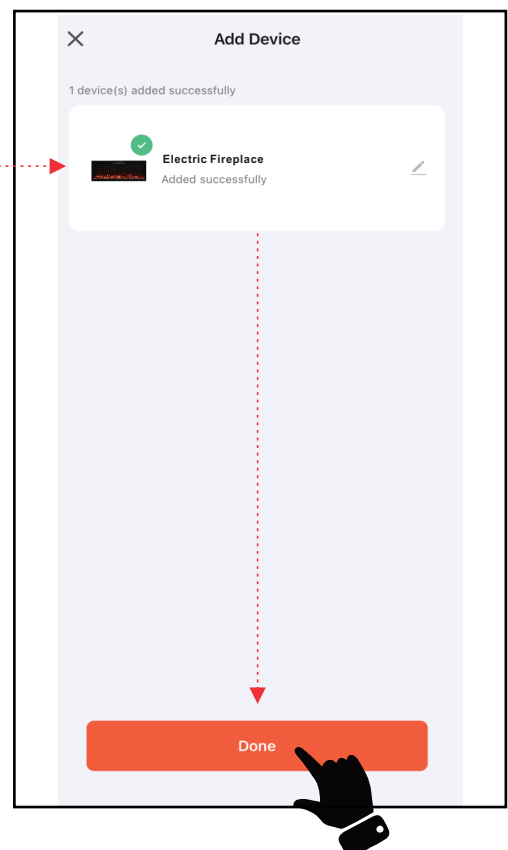
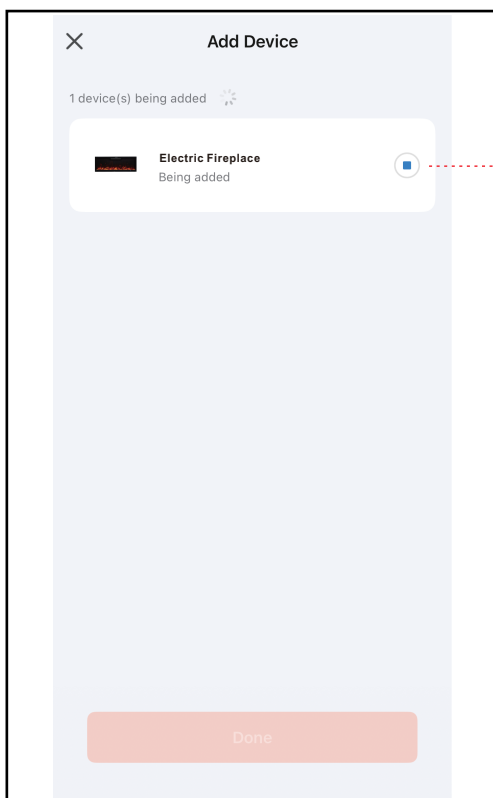
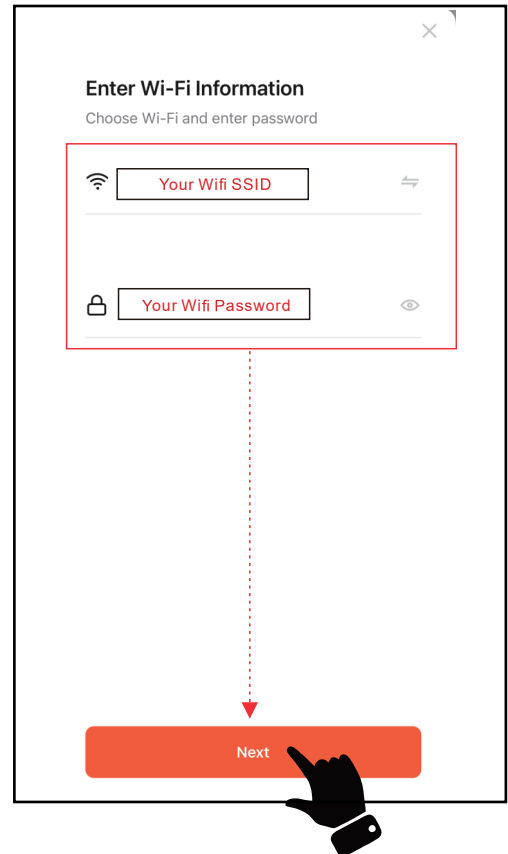
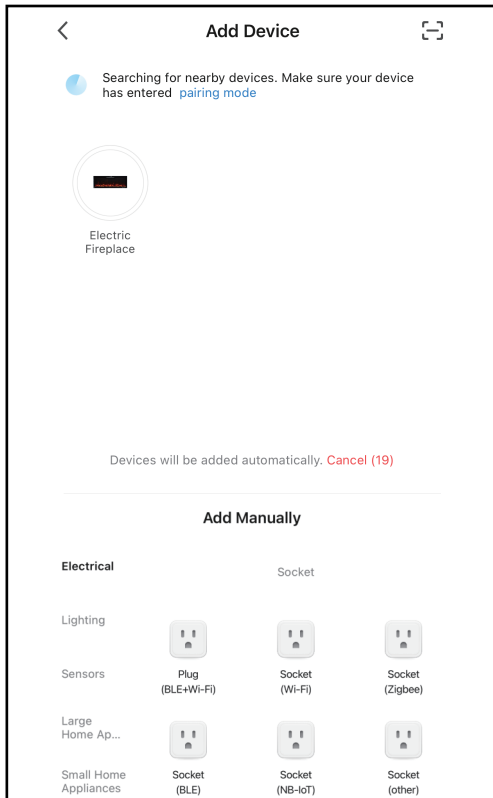
- Press & hold  from remote control or control panel until display on control panel shows “P1”.
- Enter the WIFI name and password, then press “Next” button for pairing.
- Press the **Blink Slowly** button for “P1”, Then go to connect your mobile phone to the device’s hotspot.
- Select device’s hotspot (**SmartLife-xxxx**), then back to device. Device being added.
- When complete, display on control panel shows “P4”, LED Ember-light shows **GREEN** color and flashes 6 times.



APP CONNECTION INSTRUCTIONS

4. Connecting method 3 - (Bluetooth)

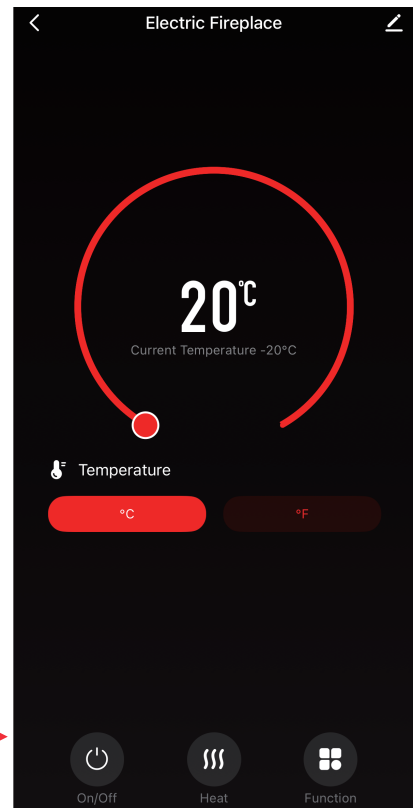
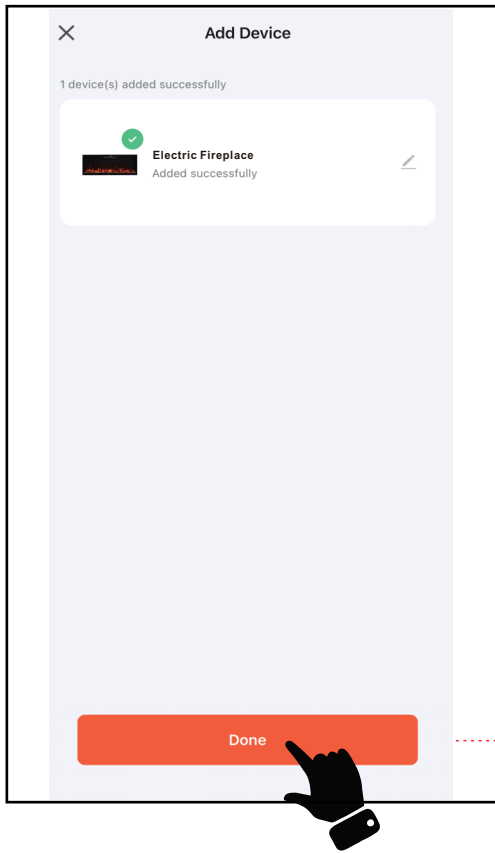
- Press & hold  from remote control or control panel until display on control panel shows “P0”.
- Press the **Add** button when you see the device named “Electric Fireplace”.
- Enter the WIFI name and password, then press “Next” button for pairing.
- When complete, display on control panel shows “P4”, LED Ember-light shows **GREEN** color and flashes 6 times.



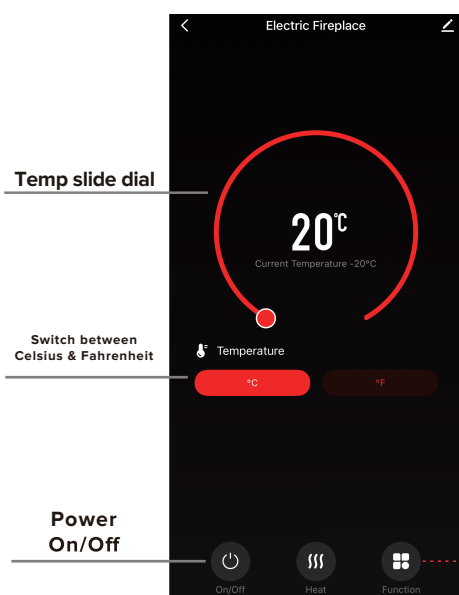
APP CONNECTION INSTRUCTIONS

5. Complete

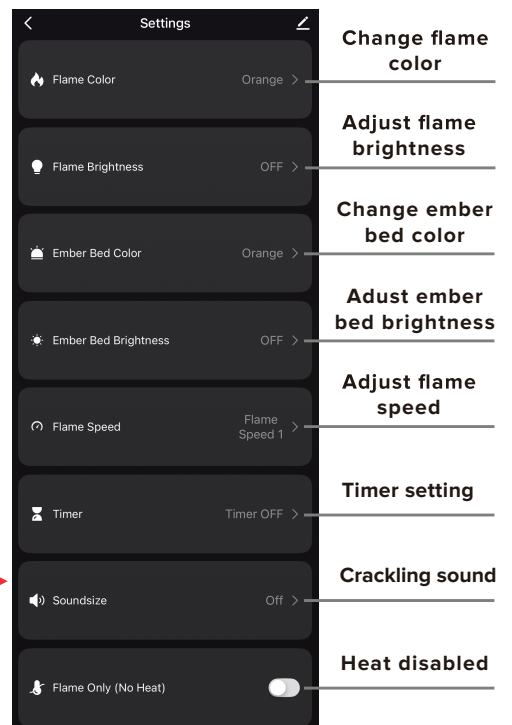
- Press **Done** to complete.



APP Operating Instruction



Heater
Off/Low/High



Luminara

LIMITED WARRANTY

Luminara Electric Hearth Appliance Warranty

Luminara provides the following warranty for electric hearth appliances purchased through an authorized Luminara dealer or distributor.

Warranty Coverage

Luminara guarantees that its products and component parts are free from defects in materials and workmanship for the duration of the warranty period. If a defect is found during this time, Luminara will, at its discretion, either repair or replace the affected component(s), or refund the original purchase price. The maximum liability under this warranty is limited to the original purchase price of the product. This warranty is transferable to future owners, but coverage duration and terms will not change upon transfer. Additional conditions, exclusions, and limitations apply (see below).

Warranty Period

Coverage begins on the installation date and lasts for two (2) years. For new home construction, coverage begins six months after the product is invoiced by an authorized Luminara dealer or distributor. Regardless of installation or purchase date, warranty coverage will begin no later than 24 months from the original Luminara shipment date.